

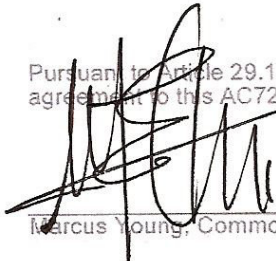

34TH AMERICA'S CUP

AC72 Class Rule

Pursuant to Article 29.1 of the Protocol Governing the 34th America's Cup, we hereby confirm agreement to this AC72 Class Rule:



on behalf of the Defender, GGYC

Marcus Young, Commodore



on behalf of the Challenger of Record, CNR

Claudio Gorelli, President

on this 15th day of October 2010.



© COPYRIGHT 2010 by America's Cup Properties, Inc.

All Rights Reserved

TABLE OF CONTENTS

SECTION A	3
1. LANGUAGE AND DEFINITIONS	3
2. UNITS OF MEASUREMENT	6
3. INTERPRETATIONS	7
4. AMENDMENTS	7
SECTION B	7
5. GENERAL	7
6. HULLS	9
7. CROSS STRUCTURE	11
8. RUDDERS	11
9. DAGGERBOARDS	12
10. WING	12
11. RIGGING	14
12. SAILS	14
SECTION C	17
13. GENERAL	17
14. HULL	18
15. TRAMPOLINE	18
16. HARDWARE AND RIGGING	18
17. SURFACE FINISHES AND BOUNDARY LAYER INTERFERENCE	19
SECTION D	19
18. CREW	19
19. STORED POWER	20
20. AC72 YACHT IDENTIFICATION AND CLASS INSIGNIA	20
SECTION E	20
21. MEASUREMENT MARKS	20
22. DECLARATIONS	20
23. INSPECTION AND MEASUREMENT	21
24. MEASUREMENT PROCEDURES	22
25. MEASUREMENT CONDITIONS	22
26. COMPLIANCE WHILE RACING	23
27. MEASUREMENT CERTIFICATE	23
APPENDICES	25
APPENDIX A — MEASUREMENT CERTIFICATE	25
APPENDIX B — CONSTRUCTION DECLARATIONS	27
APPENDIX C — HULL SYMMETRY AND MINIMUM HEIGHT DIAGRAM	29
APPENDIX D — AC72 WING	30
APPENDIX E — MEDIA EQUIPMENT AND PERSONNEL	32

INTRODUCTION

Competitors are responsible for the structural integrity of their **AC72 Yachts**, and compliance with the **Class Rule** does not necessarily assure structural integrity nor otherwise relieve the **Competitor** of this responsibility.

Competitors shall ensure that their **AC72 Yachts** comply with the **AC72 Class Rule** at all times while racing and, unless permitted under the **Rules**, that any alterations, replacements and repairs do not invalidate the measurement certificate once issued.

The **AC72 Class Rule**, the words “America’s Cup” and the Class Insignia are the property of America’s Cup Properties, Inc.

SECTION A

1. LANGUAGE AND DEFINITIONS

1.1 The official language of the **AC72 Class Rule** is English. If translated into another language, the English text shall prevail. Except for words defined herein, the meaning of any word shall be determined by reference to the Oxford English Dictionary, Second Revised Edition (2009) – CD Rom Version 4.0 (Oxford University Press 21 May 2009) or any later published version. When there is more than one definition in the Dictionary, the Measurement Committee shall determine the appropriate definition.

1.2 When a term is used in its defined sense, it is printed in bold type.

1.3 In interpreting this **AC72 Class Rule** the definitions in Article 1.1 of the **Protocol** shall apply, and:

- (a) **appendage** means any component that is outside the **hull**, excluding wing and **cross structure**, but including integral components that extend from outside the **hull** into the **hull**, (e.g., daggerboard head or rudder stock) that is:
 - i. wholly or partially submerged at any time during racing; and
 - ii. is used to affect stability, leeway, steerage, directional stability, motion damping, trim, or displaced volume.
- (b) **clew** means the area within 1.000 m of the **clew point**;
- (c) **clew point** means the intersection of the **leech** and **foot**, projected as necessary;

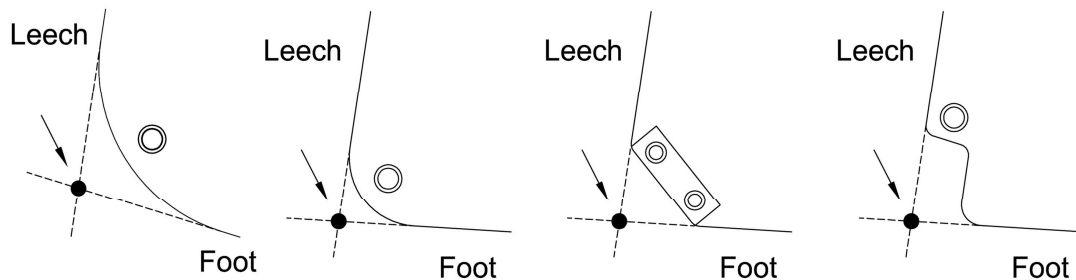

- (d) **cross structure** means structure used to connect the **hulls** or to support the **wing, rigging** or sails, including any part of this structure which extends into the **hull** and is removed from the **hull** when the **AC72 Yacht** is disassembled (per rule 7.4), and excluding trampolines;
- (e) **daggerboard** means a retractable **appendage** primarily used to affect leeway; for the purposes of the **AC72 Class Rule**, the term daggerboard is synonymous with bilge board, centerboard, lifting keel and sliding keel.
- (f) **fiber modulus** means the batch-nominal elastic modulus of the fibers in an **FRP** laminate with the modulus measured with impregnated tows, by extensometers, between 1000 and 6000 microstrains; the **Measurement Committee** will accept the following testing methods (and may accept other similar methods): SACMA-SRM16, ASTM D 4018, or JIS R 7601;
- (g) **foot** means the bottom edge of the sail in its normal configuration when in use;
- (h) **FRP** means fiber-reinforced polymer matrix composites;
- (i) **head** means the intersection of the **luff** or the extension of the **luff** and a line perpendicular to the **luff** and coincident with the uppermost point on the sail;

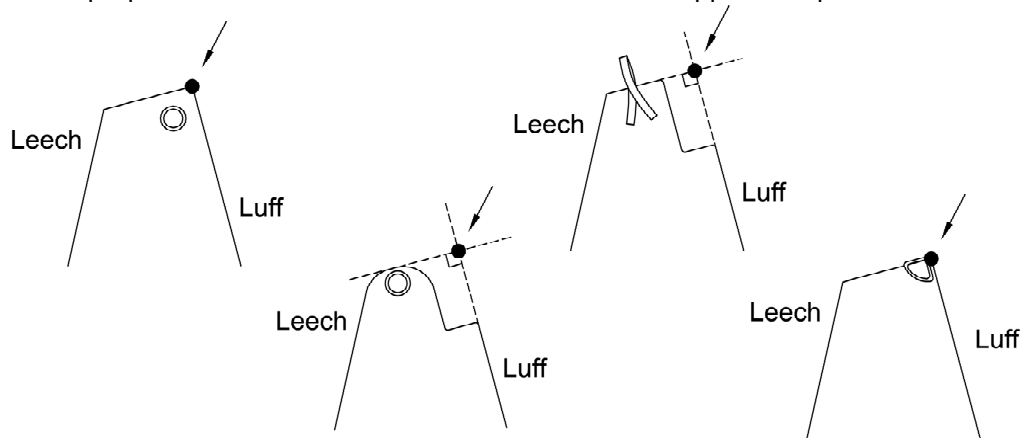

- (j) **hoist point** (or **Hoist Points A, B, C and D** as defined herein) means the intersection of a line which is the extension of the **luff** of the sail or, if used, the **luff** support device, with the leading edge of the **wing** in **wing measurement position**; the **luff** or **luff** support device shall be oriented so that its extension passes through the measurement position of the **tack point**.

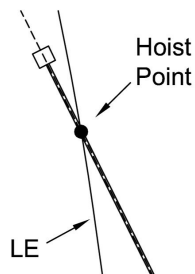

- (k) **hull** means a canoe body that displaces 45% or more of the **AC72 Yacht's** weight when floating in **measurement condition**;

- (l) **hull centerplane** means the longitudinal plane of symmetry of a **hull**;
- (m) **inboard beam waterline** means the shortest distance between the **hulls** at **MWP**;
- (n) **interpretation** means an interpretation issued in writing by the **Measurement Committee** in accordance with rule 3;
- (o) **luff** means the forward edge of the sail;
- (p) **leech** means the aft edge of the sail;
- (q) **LP** means the distance, measured perpendicular to the **luff**, from the **luff** to the **clew point** of a sail.
- (r) **Measurement Committee** means the committee appointed under Article 4.4 of the **Protocol**;
- (s) **measurement condition** means the condition of the **AC72 Yacht** as specified in rule 25;
- (t) **measurement weight** means the weight of the **AC72 Yacht** in **measurement condition**;
- (u) **measurer** means a person appointed by the **Measurement Committee** to perform measurement services or compliance checks; a **measurer** may or may not be a member of the **Measurement Committee**;
- (v) **MWP** is the flotation plane in **measurement condition**;
- (w) **rigging** means ropes, cables or rods that are primarily loaded in tension and are essentially ineffective in compression;
- (x) **rudder** means a movable **hull appendage** primarily used to affect steerage.
- (y) **sailing weight** means the sum of the **measurement weight** and the weight of the **wing** when the **wing** is in **wing measurement condition**;
- (z) **stem plane** means the vertical transverse plane that passes through the forward-most point of the **hulls** including fittings attached to **hulls**;
- (aa) **stern plane** means the vertical transverse plane that passes through the aft-most point of the **hulls** including fittings attached to **hulls**;
- (bb) **tack** means the point where the **luff** and **foot** meet, projected as necessary;

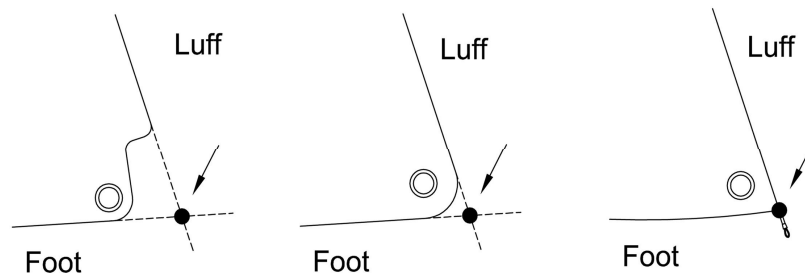

- (cc) **tack point** (or **Tack Point A** and **Tack Point B** as further defined herein) means the point on the **cross structure** where the **rigging** or fitting that supports the sail tack is attached, per rule 12.3;
- (dd) **wing** means a rigid or semi-rigid structure (encompassing a traditional yacht's mast and mainsail structures), similar to an aircraft wing fixed approximately vertically to provide propulsion from the wind;
- (ee) **wing base plane** means the plane at the base of the wing grid in Appendix D perpendicular to the **wing centerplane**;
- (ff) **wing centerplane** means the **wing's** plane of symmetry parallel to the measurement grid when the wing is in **wing measurement position**;
- (gg) **wing measurement condition** means the condition used to measure the weight and center of gravity of the **wing** per rule 25.3;
- (hh) **wing measurement position** means the position of the **wing** used to determine its area per rule 10;
- (ii) **wing rotation point** means the point about which the lowest compressive load-bearing component of the **wing** rotates relative to the **AC72 Yacht**; and
- (jj) **yacht centerplane** means the vertical longitudinal plane of symmetry of the **AC72 Yacht** that is perpendicular to **MWP**

2. UNITS OF MEASUREMENT

2.1 The Metric System shall be used for all measurements, with:

- (a) length measured in meters to three decimal places, except that sails shall be measured to two decimal places;
- (b) sailing and **wing** weights measured in kilograms to the nearest 10 kg;
- (c) area measured in square meters to two decimal places;
- (d) volumes measured in cubic meters to two decimal places;
- (e) angles measured to the nearest 0.5 degree; and
- (f) any other measurement taken to a degree of precision determined by the **Measurement Committee** as they deem appropriate.

2.2 Herein, the three major orthogonal axes of the **AC72 Yacht** are vertical, longitudinal, and transverse (vertical being normal to **MWP**, longitudinal being the intersection of the **yacht centerplane** and **MWP**, and transverse being the third).

2.3 For establishing continuing compliance with rule weight limits, the **Measurement Committee** shall determine and record the weight of any other components, modifications, repairs, additions, subtractions, and/or replacements to a degree of precision and using methodology they determine to be practical and appropriate for that purpose (including re-weighing). **Competitors** shall provide all assistance to the **Measurement Committee** required by them in tracking these changes.

- 2.4 The measuring equipment used by the **Measurement Committee** shall be the reference device for determining compliance with the **AC72 Class Rule**.
- 2.5 Herein, "between" two points or numbers means inclusive of those points or numbers, *i.e.*, "between 1.000 m and 2.000 m" means "between 1.000 m and 2.000 m inclusive."

3. INTERPRETATIONS

- 3.1 A **Competitor** may seek an **interpretation** by submitting a request in writing to the **Measurement Committee**, or the **Measurement Committee** may initiate an **interpretation**. The **Measurement Committee** shall issue **interpretations** publically within 30 days of the request or may request a longer period subject to agreement of the **Competitor** seeking the **interpretation**.
- 3.2 A **Competitor** shall not rely on any advice or opinion from a member of the **Measurement Committee** other than through an **interpretation**.
- 3.3 If a **Competitor** fails to obtain an **interpretation** regarding a feature that is not explicitly permitted by the **AC72 Class Rule**, the **Measurement Committee** may not issue, or may withdraw, the **AC72 Yacht's** measurement certificate until such design feature is the subject of an **interpretation**.

4. AMENDMENTS

The **AC72 Class Rule** may be amended at any time by unanimous consent of **Competitors** still competing, except that:

- (a) at any time the **Measurement Committee**, with the approval of the Regatta Director, may amend the **AC72 Class Rule** with respect to media requirements; and
- (b) prior to February 1, 2011, the **Measurement Committee**, with the approval of the Regatta Director and a majority of the **Competitors**, may amend the **AC72 Class Rule** in any respect.

SECTION B

5. GENERAL

- 5.1 The **AC72 Yacht** shall be a vessel, generally known as a catamaran, with two **hulls** connected by **cross structure** that are arranged symmetrically about the **yacht centerplane**, and that has two **rudders**, two **daggerboards**, and no other **appendages**.
- 5.2 The **AC72 Yacht** shall have one **wing** and the only other permitted sails are jibs, code zeros and gennakers.
- 5.3 The overall length between the **stem plane** and **stern plane**, not including equipment required or provided by **ACRM**, shall not be more than 22.000 m.
- 5.4 The **cross structure**, including fittings, shall not extend more than 26.200 m forward of the **stern plane**.
- 5.5 The overall beam of the **AC72 Yacht**, in **measurement condition** and with components in their widest possible positions, shall be not greater than 14.000 m. Appendages, in any position, shall not exceed the maximum overall beam. The beam shall be measured between vertical planes at the transverse extents of the **AC72 Yacht** parallel to the **AC72**

Yacht's centerplane.

- 5.6 Excluding the **wing**, sails (and associated hardware), **rigging**, **rudders**, **daggerboards**, instrumentation, and ACRM-mandated equipment, an **AC72 Yacht** shall have no component that is more than 2.600 m above **MWP** that:
- (a) has a chord length/thickness ratio greater than 3:1; and
 - (b) makes an angle of greater than 10 degrees to **MWP**.
- 5.7 The **inboard beam waterline** shall be not less than 11.500 m.
- 5.8 With **rudders**, **daggerboards** and any other component in their lowest possible positions, no part of an **AC72 yacht** in **measurement condition** shall extend more than 4.400 m below **MWP** ("draft").
- 5.9 The sum of the distance from **MWP** to the **wing rotation point**, and the distance from the **wing rotation point** to C9 (per appendix D), shall not be greater than 40.000 m.
- 5.10 The **sailing weight** shall be not less than:
- (a) 5700 kg nor greater than 5900 kg with the tall **wing**; or
 - (b) 5500 kg nor greater than 5700 kg with the short **wing**.
- 5.11 The **sailing weight** in rule 5.10 shall include an estimated weight for permanently mounted ACRM equipment of 180 kg, not including ACRM equipment in the **wing**.
- 5.12 An **AC72 Yacht** shall be capable of being assembled and disassembled by a **Competitor** as follows:
- (a) within 24 hours, **wings** shall be disassembled and packed in shipping boxes of the following outside dimensions:
 - (i) one box of 20.000 m x 5.000 m x 2.500 m;
 - (ii) additional boxes that will collectively fit within 5.000 m x 1.500 m x 19.000 m no one of which shall be larger than 5.000 m x 1.500 m x 9.500 m;
 - (b) within the same 24 hours, **hulls** and **cross structure** shall be disassembled and packed in shipping boxes of the following outside dimensions:
 - (i) two of 22.500 m x 2.500 m x 2.000 m;
 - (ii) two of 14.500 m x 1.500 m x 1.250 m;
 - (c) within 48 hours, from packed in the foregoing shipping boxes to assembled and ready to sail.
- Competitors** shall satisfy the **Measurement Committee** that they are capable of meeting these requirements.
- 5.13 When in **measurement condition**, **AC72 Yachts** shall be capable of being weighed by a single load cell and, when lifted, shall be approximately horizontal.

- 5.14 Devices in, on or near the surface of any **hull, rudder** or **daggerboard**, the purpose or effect of which is or could be to bleed off or alter the water or air flow of the boundary layer, are prohibited, including (but not limited to) holes in surfaces, textured surfaces, riblets, Large Eddy Break-Up Devices (LEBUs), and compliant surfaces. For the avoidance of doubt, fairings or covers on the primary lower load-bearing support of **daggerboards**, and normal through-**hull** fittings (such as self-bailers, drains, boatspeed transducers, weed-removal devices) are permitted.
- 5.15 Electric, magnetic, sonic, thermal and other methods, the purpose or effect of which is to modify the flow characteristics of the water or air in the boundary layer of any **hull, daggerboard, rudder** or **wing**, are prohibited.
- 5.16 Gases with a density less than standard atmosphere air shall not be used to reduce the weight of an **AC72 Yacht**.

6. HULLS

- 6.1 Other than sails and **rigging**, no component shall extend forward of the **stem plane** within 1.000 m of the **hull centerplane**.
- 6.2 Water, the weight of which could increase performance, shall not be retained in the bilge, any recess, or other volume. Any recess in the **hull** capable of retaining water at any heel angle less than 25 degrees or at any trim angle less than 10 degrees must be self draining with the size of the drain at least 0.006 m² per 1.0 m³ of the recess volume that could contain water in **measurement condition**.
- 6.3 No part of a **hull** shall be adjusted or trimmed, except for permitted fairings under rule 5.14.
- 6.4 **Hulls** and **cross structure** shall not be adjusted, relative to each other, by any mechanism. For the avoidance of doubt, this rule does not limit normal deflections caused by sailing loads.
- 6.5 The intersection of any **hull, cross structure** or **rigging** shall be at least 1.000 m forward of the **stern plane**, and shall be no further forward than the forward watertight bulkheads required under rule 6.11.
- 6.6 The intersection of the **hull centerplane** and the **stern plane** shall be no greater than 10 degrees from vertical.
- 6.7 Each **hull** shall be symmetrical, within +/- 0.005 m, about its **hull centerplane** except **hull** surface that is:
- between transverse planes 1.000 m forward and 13.000 m forward of the stern plane that is also 0.400 m or more above **MWP** as shown in Appendix C;
 - in way of **daggerboards, rudders**, bearings and openings and their fairings of a size consistent with the operation of the **daggerboard** or **rudder**; and
 - for local reinforcement necessary for fittings.
- 6.8 The highest point of any transverse section through the **hull** surface, outboard of the **hull centerplane**, shall be higher than a line joining a point 0.950 m above **MWP** at 1.000 m forward of the **stern plane**, to a point 1.100 m above **MWP** at 13.000 m forward of the **stern plane**, except for:

- (a) the **hull** less than 1.000 m forward of the **stern plane**; and
- (b) the **hull** less than 1.000 m aft of the **stem plane**.

See Appendix C.

6.9 The enclosed volume of each **hull** shall be not less than:

- (a) 5.5 m³ forward of a plane 13.000 m forward of the **stern plane**; and
- (b) 8.5 m³ aft of a plane 13.000 m forward of the **stern plane**.

6.10 The **hull** between the **stem plane** and a plane between 0.900 m and 1.000 m aft of the **stem plane**, and the **hull** between the **stern plane** and a plane between 0.900 m and 1.000 m forward of the **stern plane**, shall be replaceable by “replacement sections” as follows:

- (a) each **Competitor** shall have one forward replacement section and one aft replacement section available for use at a regatta;
- (b) the **Competitor** shall notify the **Measurement Committee** before any replacement section is installed; and
- (c) the **Measurement Committee** shall be satisfied that an **AC72 Yacht** fitted with a replacement section complies with the **AC72 Class Rule**.

6.11 Watertight bulkheads shall be located in each **hull** between:

- (a) 1.000 m and 1.500 m aft of the **stem plane**, and
- (b) 1.000 m and 1.500 m forward of the **stern plane**.

6.12 Hatches are permitted in the **hull** provided they shall:

- (a) be closed by a cover permanently attached to the **hull** by hinges, slides or similar arrangement;
- (b) be watertight, meaning a closed hatch shall prevent the ingress of water from a garden hose applied from any direction;
- (c) meet the **hull** construction requirements in rule 14 or shall be compliant with ISO12216, Area II, Design Category C; and
- (d) be at least 0.600 m above **MWP**.

6.13 Ports for hand access are permitted, provided each does not exceed 0.100 m² and is secured by a watertight cover.

6.14 Small openings in **hulls** for **rigging** to pass through, and for attachments, are permitted provided they shall:

- (a) be no larger than required for their specific task;
- (b) have a rubber gaiter boot or other means of closing the opening if the area exceeds

0.005 m²;

- (c) be aft of 13.000 m from the **stern plane**; and
- (d) be at least 0.700 m above **MWP**.

6.15 **AC72 Yachts** shall have one media bay fixed in each **hull** to accommodate the ACRM-provided media equipment per Appendix E. The media bays shall be located between 8.000 m and 13.000 m forward of the **stern plane** and shall be easily accessible between races.

7. CROSS STRUCTURE

7.1 **Cross structure** or fittings attached to **cross structure** shall be no further aft than 1.000 m forward of the **stern plane**, except non-structural aerodynamic beam fairings that serve only as such and comply with rule 7 provided they extend no further aft than the **stern plane**.

7.2 No part of **cross structure**, including fairings or other surfaces, shall move (translate or rotate about any axis) or be adjusted relative to any other part of the **cross structure**, except for normal deflections caused by sailing loads.

7.3 Any recess in the **cross structure** capable of retaining water at any heel angle less than 25 degrees or at any trim angle less than 10 degrees must be self draining, with the size of the drain at least 0.006 m² per 1.00 m³ of the recess volume that could contain water in **measurement condition**.

7.4 **Cross structure** shall be easily demountable from the **hulls**, and no part of the **cross structure** shall be laminated or bonded to the **hulls**;

7.5 No part of **cross structure** or its fittings, external to any **hull**, shall be less than 0.150 m above **MWP** or greater than 2.400 m above **MWP**.

8. RUDDERS

8.1 Each **hull** shall have one rudder. The rudder or rudder stock shall penetrate the **hull**.

8.2 No part of a rudder, through its entire range of motion, shall be less than 1.000 m or greater than 3.000 m forward of the **stern plane**.

8.3 Rudders shall rotate only about a single axis and within 10 degrees of vertical.

8.4 Rudders shall not translate in any direction.

8.5 Rudders (including rudder stocks) shall not exceed 5.000 m in any direction, measured along a straight line.

8.6 Rudders shall not have components such as trim tabs or moveable winglets that can be adjusted while racing, however, a movable or retractable device whose sole purpose is the removal of weed or debris is permitted.

8.7 While an **AC72 Yacht** is moored, rudders shall be capable of:

- (a) freely rotating through 360 degrees; or

- (b) being removed without the assistance of a crane (shore-based, floating or otherwise).

9. DAGGERBOARDS

- 9.1 Each **hull** shall have one daggerboard.
- 9.2 Daggerboards shall penetrate the **hull** forward of the rudder and aft of the forward watertight bulkhead per rule 6.11.
- 9.3 The maximum dimension of any daggerboard shall be 7.000 m in any direction, measured along a straight line.
- 9.4 The primary lower load bearing support of each daggerboard may only rotate about a single axis and shall not translate in any direction.
- 9.5 A daggerboard shall not translate along the longitudinal axis more than 0.020 m within its primary lower load-bearing support.
- 9.6 Daggerboards shall not have components such as trim tabs or moveable winglets that can be adjusted while racing; however, a movable or retractable device the sole purpose of which is the removal of weed or debris is permitted.
- 9.7 Daggerboards shall be capable of being raised without the assistance of a crane (shore-based, floating or otherwise) so that, when the **AC72 Yacht** is moored, the daggerboards do not extend more than 0.300 m below the local hull surface.
- 9.8 Daggerboard cases shall be capable of draining within ten seconds of the hull being lifted above the water level.

10. WING

- 10.1 The **wing** shall be symmetrical about the **wing centerplane** within a tolerance of 0.005 m in **wing measurement position**.
- 10.2 If shrouds are adjusted while racing, the port and starboard shrouds shall be connected in a master-slave relationship so they always have the same extension. For the avoidance of doubt, the **wing** shall not be canted to windward.
- 10.3 Further to Protocol Article 29.6, the **wing spar** shall be capable of being disassembled into two separate sections. The lower **wing spar** section shall be at least 18.000 m, and no more than 19.900 m in length. For the purposes of this rule, fittings shall not be considered part of the **wing spar**.
- 10.4 The **AC72 yacht** shall have a single **wing rotation point** that shall be:
 - (a) within 0.020 m, of the **yacht centerplane**;
 - (b) located on the plane of symmetry of the **wing** in **wing measurement position**; and
 - (c) between 1.900 m and 2.400 m above **MWP**.
- 10.5 A **wing** measurement grid shall be established per Appendix D. The **wing**, when all movable measured **wing** surfaces are oriented symmetrically about the **wing centerplane**, shall be placed over the grid with the **wing centerplane** parallel to the grid surface so the

- top of the **wing** is at C12 for the tall wing, and at C9 + 500 for the short wing and the perimeter line of the **wing** lies between the wing outline inner and outer extents (see Appendix D).
- 10.6 The total area enclosed within the perimeter line of the **wing** in **wing measurement position** shall be:
- (a) not greater than 260.00 m² nor less than 255.00 m² for the tall wing; and
 - (b) not greater than 230.00 m² nor less than 225.00 m² for the short wing.
- 10.7 The total enclosed area shall be calculated using the chord length measured at the reference chords (between Appendix D C1 and C11 for the tall **wing**, and between C1 and C9 for the short **wing**) and integrated using Simpson's rule. **Wing** areas above C11 for the tall **wing** and above C9 for the short **wing** and below C1 shall be measured and included in the total **wing** area (see Appendix D). The perimeter line shall:
- (a) be taken as a line drawn around the largest extent of the measured area of the **wing**;
 - (b) not have hollows (except for hollows created by fittings and local reinforcements) and in its forward-most edge, and hollows elsewhere shall be bridged by the perimeter line; and
 - (c) not include **wing** components used to connect the **wing** to the **wing rotation point** provided the components do not have a chord length/thickness ratio greater than 3:1 and do not provide unmeasured wing area; and
 - (d) elements with a measured girth of less than 0.150 m shall not be included in the area calculation provided such elements do not increase the effective **wing** area.
- 10.8 If, in the opinion of the **Measurement Committee**, the **wing** area is not accurately measured by this method, they may devise and use another method.
- 10.9 The half-girth of the convex side of the **wing** in any chordwise plane, parallel to the **wing base plane**, shall not increase more than 1.75% in any cambered orientation from its half-girth in **wing measurement position** (see Appendix D). The maximum measured girths shall be limited by a mechanical system to the satisfaction of the **Measurement Committee**.
- 10.10 When the **wing** is in **wing measurement position**, and when viewed perpendicular to the **wing base plane** the projected area of all components, excluding rigging, of the **wing**:
- (a) above C10 for the tall **wing**, and above C8 for the short **wing**, shall not exceed 2.25 m²; and
 - (b) below 2.000 m, from the **wing base plane** shall not exceed 5.50 m².
- 10.11 The leading edge of the **wing** shall be straight (within a tolerance of 0.003 m) below grid C3.
- 10.12 The weight of the tall **wing** in **wing measurement condition** shall be not less than 1325 kg, and the center of gravity shall be not less than 15.250 m above the **wing base plane**. The weight of the short **wing** in **wing measurement condition** shall be not less than 1125 kg, and the center of gravity shall be not less than 13.000 m above the **wing base plane**.

10.13 **Wing** weight and center of gravity in rule 10.12 includes a weight allowance for permanently mounted media equipment as follows:

- (a) for the tall wing, 21.5 kg at 22.000 m above the **wing base plane** for the tall wing; and
- (b) for the short wing, 15.3 kg at 18.900 m above the **wing base plane**.

11. RIGGING

11.1 **Rigging** and non load-bearing **rigging** fairings shall have a maximum girth of 0.150 m, and a chord length/thickness ratio greater than 3:1

12. SAILS

12.1 **Hoist points:**

- (a) for the tall **wing** shall be;
 - (i) **Hoist Point A**, between 36.000 m and 37.000 m above the **wing base plane**; and
 - (ii) **Hoist Point B**, between 34.000 m and 35.000 m above the **wing base plane**;
- (b) for the short **wing** shall be;
 - (i) **Hoist Point C**, between 26.000 m and 29.200 m above the **wing base plane**;
 - (ii) **Hoist Point D**, between 26.000 m and 27.000 m above the **wing base plane**; and
- (c) For the avoidance of doubt, an **AC72 Yacht** may have multiple halyards at each **hoist point**.

12.2 **Tack points** shall be:

- (a) for **Tack Point A**, not forward of 26.000 m from the **stern plane**, and not forward of a point that would result in a JA measurement, per rule 12.5, greater than 13.000 m;
- (b) for **Tack Point B**, not forward of 22.000 m from the **stern plane**, and not forward of a point that would result in a JB measurement, per rule 12.5, greater than 9.000 m;
- (c) measured as the attachment point of the **tack** to the top of the **cross structure**;
- (d) between 1.900 m and 2.200 m above **MWP**; and
- (e) within 0.030 m of the **yacht centerplane**.

12.3 No sail shall be set so that its **head** is above its **hoist point** or so that its **tack** is below its **tack point**.

12.4 In determining **JA** and **JB**, the measurer shall transfer the point defined by the intersection of C1 and the leading edge of the **wing**, in **wing measurement position**, to the cross structure (using the **wing rotation point** as a reference and aligning **MWP** and the **wing base plane**). The longitudinal distance between that point and **Tack Point A** is **JA**, and between that point and **Tack Point B** is **JB**.

12.5 Tall **wing** jibs:

- (a) shall not be tacked forward of **Tack Point B**;
- (b) shall be flown within the region allowed for **Hoist Point B**;
- (c) shall have an **LP** measurement no greater than 9.540 m;
- (d) shall have a three-quarter width (measured perpendicular from **luff** to **leech**) no greater than 33% of the **foot** length;
- (e) may have battens;
- (f) shall have no battens within 3.000 m of the **head**; and
- (g) shall have no battens below a line joining points 1.000 m above the **clew** and 1.000 m above the **tack**.

12.6 Short **wing** jibs:

- (a) shall not be tacked forward of **Tack Point B**;
- (b) shall be flown within the region allowed for **Hoist Point D**;
- (c) shall have an **LP** measurement no greater than 9.275 m;
- (d) shall have a three-quarter width (measured perpendicular from **luff** to **leech**) no greater than 33% of the **foot** length;
- (e) may have battens;
- (f) shall have no battens within 3.000 m of the **head**; and
- (g) shall have no battens below a line joining points 1.000 m above the **clew** and 1.000 m above the **tack**.

12.7 Tall **wing** code zeros shall:

- (a) not be tacked forward of **Tack Point A**;
- (b) be flown within the region allowed for **Hoist Point A** or **Hoist Point B**;
- (c) have an **LP** measurement no less than 12.770 m and no greater than 11.270 m; and
- (d) not have battens.

12.8 Tall **wing** gennakers shall:

- (a) not be tacked forward of **Tack Point A**;
 - (b) be flown within the region allowed for **Hoist Point A**;
 - (c) have an **LP** measurement no less than 14.000 m; and
 - (d) not have battens.
- 12.9 Short **wing** gennakers shall:
- (a) not be tacked forward of **Tack Point A**;
 - (b) be flown within the region allowed for **Hoist Point C**;
 - (c) have an **LP** measurement no less than 12.250 m; and
 - (d) not have battens.
- 12.10 When using the tall **wing** only tall **wing** sails may be used, and when using the short **wing** only short **wing** sails may be used.
- 12.11 Other than for sail hardware, intentional openings are prohibited.
- 12.12 Sails shall not have more than 6 battens and battens shall be at least than 1.000 m between battens.
- 12.13 Artificially thickened sails are prohibited, e.g., foamed sails or rigid sails and multiple-surface sails, whether inflated by the action of the wind or otherwise, except for battens and batten pockets as provided in rule 12.15.
- 12.14 Battens:
- (a) shall pass through a 0.075 m diameter circle;
 - (b) may consist of multiple elements that need not necessarily be attached to one another, provided they shall be in close proximity over their entire length, and the multi-element array complies with (a) above;
 - (c) shall be approximately straight within a tolerance of 0.100m either side of a straight line;
 - (d) shall not be adjusted when a sail is set;
 - (e) shall not be inflatable;
 - (f) may be inside a pocket not exceeding 0.150 m width measured normal to the batten; and
 - (g) shall be oriented not less than 30 degrees to the local **luff**.
- 12.15 The dimension of any sail hardware, in any direction, shall not exceed 0.750 m for a **clew** board, or 0.250 m for any other hardware.
- 12.16 Any sail may be attached to **rigging** along its **luff** provided the attachments measure no more than 0.120 m perpendicular to the **luff** and 0.075 m parallel to the **luff** and these

attachments are no closer than 1.000 m to each other. No **luff** support device may be used to increase effective sail area.

12.17 No device shall control a sail except:

- (a) sheets on the **clew** to sheeting points on the **hull** or **cross structure**;
- (b) a cunningham system near the **tack**;
- (c) leech and foot lines no greater than 0.003 m in diameter;
- (d) a furling system; and
- (e) a tacking line on or near the **foot**, the purpose of which is to bring the **clew** of the sail forward during a tack or gybe, provided the tacking line is not used to sheet the sail in any way.

SECTION C

13. GENERAL

- 13.1 Limits on materials and construction methods in rule 13 apply except where altered by rules 14 through 17.
- 13.2 A maximum of 40 kg of **FRP** constituent parts from commercially available ex-stock material (e.g. tube, plate, etc.) may be used in the construction of the **AC72 Yacht**, provided that no single constituent part exceeds 10 kg. These constituent parts are not limited by the building methods otherwise set out in **AC72 Class Rule**.
- 13.3 Boron and Beryllium are prohibited except when used as an alloy in concentrations of less than 0.00042%.
- 13.4 The use of electron beam or any other non-thermal radiation cure of composites is prohibited. This does not prohibit the use of conductive heating with electrical current for the cure of composites.
- 13.5 Sandwich construction techniques are permitted. Any component materials used in the manufacture of core shall have a modulus in any direction not exceeding 75 GPa, and shall only be composed of aluminum honeycomb, meta-aramid (Nomex) honeycomb, or foam.
- 13.6 The temperature of **FRP** components, other than sails, shall not exceed 135 degrees Celsius at any time during construction and post construction.
- 13.7 No **FRP** component shall have **fiber modulus** greater than 395 GPa.
- 13.8 Isotropic materials shall have elastic modulus less than 220 GPa.
- 13.9 Pressure applied at any time during construction to **FRP** components, other than sails, shall not exceed 7 atmospheres, but this limitation shall not prohibit building methods including the use of clamps or mechanical fastenings, wrapping, and winding etc.
- 13.10 Materials with elastic modulus exceeding that specified in **AC72 Class Rule** may be used provided:
 - (a) the largest dimension of each particle does not exceed 1 micron; and

- (b) the total weight of these materials used in any composite component does not exceed 1.0% of the weight of that composite component.

14. HULL

- 14.1 No **FRP** in the **hull** and its internal structure shall have **fiber modulus** greater than 245 GPa.
- 14.2 **Hulls** and its internal structure shall not have pressure applied at any time during construction that exceeds one atmosphere, but this limitation shall not prohibit building methods including the use of clamps or mechanical fastenings, wrapping, and winding, etc.
- 14.3 Skin weight of any external **hull** surface shall be not less than 900 g/m², including fiber and resin but not including any paint, fairing or core bond adhesive. This limit only applies to areas of the **hull** that are exposed to the weather.
- 14.4 Core of the hull or watertight bulkheads as per rule 6.11, shall not have a density less than 50 kg/m³.
- 14.5 Skin weight of watertight bulkheads as per rule 6.11, shall be not less than 900 g/m², including fiber and resin on either side of a core that is no less than 15 mm thick.

15. TRAMPOLINE

- 14.1 Trampolines shall be fixed to the **hulls** and **cross structure**, and shall:
- (a) be strongly secured with regular spacing on their support edges; this spacing shall not be greater than 1.000 m when tensioned but without supporting the weight of crew or sails; gaps between the trampoline and the **hulls** or **cross structure** shall not be greater than 0.200 m when tensioned but without supporting the weight of crew or sails;
 - (b) be able to support local loadings equivalent to the weight of the crew and sails in normal working conditions at sea;
 - (c) cover all open areas between the **hulls** from the **wing rotation point** aft to aft extent of **cross structure**;
 - (d) cover all open areas in a triangle with a base of a 3.000 m transverse line centered on the **wing rotation point** forward to an apex of **Tack Zone B**.
 - (e) be constructed of a netting of rhombus-shaped cells, of a size such that a cylinder with a diameter of 0.050 m shall not pass through any cell of the netting while tensioned;
 - (f) have a minimum twine diameter of 2.7mm; and
 - (g) be made of material with a fiber modulus not greater than 135 GPa;

16. HARDWARE AND RIGGING

- 16.1 Hardware and fittings shall be constructed of wood, polymer, aluminum alloys, **FRP**, titanium, or steel and steel alloys, bronze, brass or a combination thereof.
- 16.2 **Rigging** shall be constructed of steel, aluminum, bronze, brass, polymer or fibrous materials (carbon, aramid, or polymer fibers), or a combination thereof.

17. SURFACE FINISHES AND BOUNDARY LAYER INTERFERENCE

- 17.1 Only paint systems generically specified as two-component linear polyester saturated aliphatic polyurethane, two component epoxy urethane, or two component acrylic urethane, and manufactured by International, Awlgrip, Akzo Nobel or Resene, may be used as the outermost surface finish of the **hulls, rudders** and **daggerboards**. No materials other than specified manufacturer-supplied retardants, accelerants, thinners and pigments shall be added. Similarly, the specific gravity of the paint shall not be altered with any material other than those specified above. The **Measurement Committee** may authorize the use of paint products manufactured by another manufacturer if it meets the requirements for product standardization, compliance, and testing.
- 17.2 The application of vinyl-film over the surface of the **hull** is allowed, provided it shall not be specially textured in a way that could improve the character of the flow of water inside the boundary layer.
- 17.3 The outermost surfaces of the **hull** or **appendages** may be sanded and cleaned with normal concentrations and quantities of detergents or similar materials. However, while afloat on a scheduled race day, no substances shall be present on the outermost surfaces of the **hull, rudder** or **daggerboard** other than those permitted in the rule.

SECTION D

18. CREW

- 18.1 There shall be eleven crew (unless reduced while racing due to accident or injury), and the total crew weight, in clothing worn while racing, shall not be greater than 1012 kg or less than 957 kg. If eleven crew members do not reach minimum crew weight, then corrector ballast shall be added to the **AC72 Yacht** to reach 957 kg; such corrector ballast shall be fixed during a **sailing series**, and shall be located within 2.000 m of the **Wing Rotation Point**;
- 18.2 Crew shall not be inside the **hull** enclosed volume (per rule 6.9) except during emergencies and briefly to perform inspections.
- 18.3 Crew shall only use the following devices to position their bodies outboard of the local beam:
- (a) hiking straps connected to the **hull**;
 - (b) shrouds and shroud fittings within 0.200 m of the local **hull**;
 - (c) winches and winch handles; and
 - (d) sail control lines whose anchor points for hiking are connected to the **hull** or **cross structure**; making loops on sail control lines to aid hiking is prohibited.
- 18.4 The crew shall be positioned as follows:
- (a) when using devices per rule 18.3, crew shall only sit with feet inboard or be in a prone position on the hull, and:
 - (i) when hiking in the sitting position no part of the crew's body between the middle of the thigh and feet shall be outboard of the local beam; and

- (ii) when hiking in the prone position at least half the torso, one full arm and one full leg shall be inboard of the local beam.

- (b) above a plane 0.300 m above **MWP**.

19. STORED POWER

19.1 **Rigging**, sails, **rudders** and **daggerboards** shall be only adjusted manually, and the use of stored energy is prohibited, except:

- (a) for small springs, shockcord, and similar devices;
- (b) low pressure hydraulic or gas accumulators of less than 6 bar which provide back pressure to a hydraulic system to prevent cavitation, but do no significant work themselves;
- (c) batteries to power electric bilge pumps, provided the total capacity is not greater than 200 l/min; and
- (d) batteries to power instruments and ACRM media equipment.

20. AC72 YACHT IDENTIFICATION AND CLASS INSIGNIA

20.1 **AC72 Yacht** identification numbers shall be allocated sequentially by the **Measurement Committee**, except numbers that may be culturally objectionable may be skipped at the discretion of the **Measurement Committee**. When an **AC72 Yacht's** ownership is transferred from one country to another, it shall retain the same identification number with only the national letters being changed.

20.2 A new identification number (in sequence) may be reserved by a team when construction of an **AC72 Yacht's hull** has commenced.

20.3 A new identification number shall be issued to the **AC72 Yacht** when a measurement certificate is issued or when otherwise required by the Protocol.

20.4 Class insignia and **AC72 Yacht** identification number shall be displayed on the top 25% of the **wing**. Details of the insignia and identification number shall be published by the Regatta Director and may be amended from time to time.

SECTION E

21. MEASUREMENT MARKS

21.1 The **Measurement Committee** may place measurement marks on **AC72 Yachts**. Such marks include, but are not limited to, reference screws or punch marks, measurement bands on spars, and measurers' signatures and/or seals or stickers on any component.

21.2 Measurement marks of any type placed or otherwise confirmed by a member of the **Measurement Committee** shall not be moved, removed, altered, or replaced without their written permission.

22. DECLARATIONS

- 22.1 **Competitors** shall provide the **Measurement Committee** declarations signed by the relevant designer(s), builder(s) and **Competitor's** representative affirming that:
- (a) **hull(s)** have been constructed from materials (including surface finishes) and using the methods permitted by the **AC72 Class Rule**;
 - (b) **cross structure** has been constructed from materials and using the methods permitted by the **AC72 Class Rule**;
 - (c) **rudders and daggerboards** have been constructed from materials (including surface finishes) and using the methods permitted by the **AC72 Class Rule**; and
 - (d) the **wing** and associated **rigging** have been constructed from materials and using the methods permitted by the **AC72 Class Rule**.

The form of this declaration shall be as shown in **AC72 Class Rule** Appendix B.

- 22.2 **Competitors** shall provide a material-usage schedule and the material manufacturer's certificate of compliance for **FRP** used in each component described in rule 22.1 to the **Measurement Committee**. However, documentation is not required for wet-laminate **FRP** materials used in the construction of any component, provided that the total quantity of wet-laminate **FRP** is less than 5% by weight of the total **FRP** materials used in the construction of that component. Nonetheless, wet-laminate **FRP** mechanical properties shall comply with the **AC72 Class Rule** governing the component. Details of the documentation required shall be published by the **Measurement Committee** per rule 24.1.

23. INSPECTION AND MEASUREMENT

- 23.1 **Competitors** shall permit and assist all inspections and measurements by a **measurer** and the **Measurement Committee** and shall afford all reasonable facility to carry out such measurements and inspections, including during construction. **Competitors** shall provide measurement information reports to measurers as requested.
- 23.2 The **measurer** shall take at least four hull laminate samples per hull no larger than 0.065 m in diameter from a location of their choosing.
- 23.3 The **Measurement Committee** reserves the right to take samples of the paint or vinyl from the **hull** and/or **appendages** for analysis by the manufacturer to ensure that only the specified paint systems have been used
- 23.4 An **AC72 Yacht** may be re-measured at the discretion of the **Measurement Committee**.
- 23.5 A **measurer** who becomes aware that a **Competitor** may have failed to comply with any **AC72 Class Rule** shall advise the **Measurement Committee**.
- 23.6 The specific gravity of the seawater shall be measured and recorded at the time of measurement afloat. When specific gravity of the water varies from 1.025, the **measurer** shall correct floatation measurements as necessary;
- 23.7 Weights shall be calibrated for local gravitational effects.
- 23.8 When carrying out measurement ashore, the **measurer** shall allow a reasonable time to drain water from the **AC72 Yacht** equipment and allow the substitution of wet **rigging** with equivalent dry **rigging**.

24. MEASUREMENT PROCEDURES

- 24.1 The **Measurement Committee** will create, and amend when needed, a document specifying procedures they will use to confirm compliance with the **AC72 Class Rules**. This document is to be available to all **Competitors**.

25. MEASUREMENT CONDITIONS

- 25.1 The **AC72 Yacht** shall be brought to **measurement condition** to determine the **measurement weight**. The **measurement condition** includes everything that could be on the **AC72 Yacht** during a race except the following:

- (a) the **wing** as it was weighed in **wing measurement condition**;
- (b) ACRM personnel, guests and equipment that is not permanently installed on the **AC72 Yacht**;
- (c) crew;
- (d) crew clothing and equipment that is normally carried on the person while racing but limited to a maximum of 6.00 kg per crewmember;
- (e) sails (including sail bags, luff cables and hanks) ; and
- (f) food and drinks.

- 25.2 **MWP** shall be determined when the **AC72 yacht** is floating in **measurement condition** and:

- (a) all movable equipment is approximately centered, transversely and 11.000 m forward of the **stern plane**;
- (b) **rudders** and **daggerboards** shall be in their lowest possible positions (per rule 5.8);
- (c) **rudder** and **daggerboard** cases may be flooded provided that the total volume of all cases is no greater than 50.0 liters; and
- (d) no other part of the **AC72 Yacht** shall be flooded.

- 25.3 The **wing** in **wing measurement condition** shall:

- (a) be capable of being weighed by suspension from only two points;
- (b) be oriented as per **wing measurement position**;
- (c) include all **rigging**, spreaders, jumpers and jumper systems, diamonds, all backstays, runner fly blocks (but excluding runner tails), check stays, instruments, instrument sensors, cameras, cables, permanently-installed ACRM media equipment, hydraulic rams, and pipework;
- (d) include all wing fittings required to sail the yacht, including mast jacks if an integral part of the wing, halyard locks, spreader fittings;
- (e) exclude all halyards, however, halyards may be replaced with light weight mouse lines not exceeding 0.004 m diameter;

- (f) have all **rigging** in place and pulled down tight along the **wing**; and
- (g) be the configuration which achieves the lowest center of gravity.

25.4 Any component that remains attached to the **wing** when the **wing** is removed from the **AC72 Yacht** is deemed to be part of the **wing** for measurement purposes, and equipment (including halyards) not weighed, as part of the **wing** weight and center of gravity shall be included in the **measurement weight**.

26. COMPLIANCE WHILE RACING

While racing:

- (a) the **sailing weight** of the **AC72 Yacht** shall not be less than the sailing weight on it's certificate, nor more than 100 kg greater than the sailing weight on it's certificate;
- (b) dead weight, ballast, sails and other equipment shall not be moved for the purpose of changing trim or stability; however, bilge water shall be promptly removed;
- (c) three sails are allowed on board with the tall **wing**, one of which shall be a jib; two sails are allowed on board with the short **wing**, one of which shall be a jib; the total weight of sails (including sail bags, **luff** cables and hanks) shall be between:
 - (i) 220 kg and 250 kg for the tall wing; and
 - (ii) 120 kg and 150 kg for the short wing;
- (d) and the total weight of consumable stores shall be not greater than 20 kg.

27. MEASUREMENT CERTIFICATE

27.1 When the **Measurement Committee** concludes that the **AC72 Yacht** has satisfied all the measurement checks requested, it shall issue to the **Competitor** a measurement certificate as in Appendix A and shall retain a copy for its own records. The **Measurement Committee** shall provide a copy of the front page to the **Regatta Director** for public dissemination.

27.2 Except for repair of, or replacement for, unintended damage, the measurement certificate ceases to be valid if there is any change to:

- (a) any information recorded on the **AC72 Yacht's** measurement certificate, except that when not racing the following changes are permitted:
 - (i) rudder stock movement that is less than 0.010 m provided that after the movement the rudder complies with rule 8;
 - (ii) **wing** weight and **wing** CG, provided those changes are still within the limits of rule 10.12; and
 - (iii) any change in weight or the distribution of weight, provided that **MWP** would not change more than 0.004 m at the **stern plane** or **stem plane**.

and the limits set per rule 26(a) are complied with;

- (b) the shape of the **hull** surface;
- (c) the shape of the **appendage** surfaces;

- (d) the shape of the **cross structure** (excluding fittings); or
 - (e) the shape of the measured **wing** surface area in **wing measurement position**.
- 27.3 **Competitors** shall obtain written approval of the **Measurement Committee** prior to making any repairs or replacements.
- 27.4 The **Measurement Committee** will only give written approval to replace an item when they are satisfied that the damaged item cannot be repaired in a reasonable regatta-constrained timeframe.
- 27.5 After repair or replacement, **Competitors** shall satisfy the **Measurement Committee** that the **AC72 Yacht** complies with the **AC72 Class Rule**.
- 27.6 The **Measurement Committee** shall withdraw an **AC72 Yacht's** measurement certificate when they have reason to believe it no longer complies with this **AC72 Class Rule**.
- 27.7 An **AC72 Yacht** shall have only one valid measurement certificate at any one time.
- 27.8 The **Measurement Committee** shall hold, in perpetuity, **AC72 Yacht** data and information in strict confidence.

APPENDICES

APPENDIX A — MEASUREMENT CERTIFICATE

AC72 Yacht
Measurement Certificate



Name of Yacht:

Yacht Identification Number:

Measurement Certificate Number:

Designer(s):

Builder(s):

Owner(s):

VALIDATION

We confirm that this yacht has been measured in accordance with the **AC72 Class Rule**, and has been found to be in compliance with the rule.

Signatures of issuing Measurers:

(on behalf of the Measurement Committee)

Date of certification:

Supersedes Certificate No. & Date:

Certificate Number

Yacht ID number

General

Overall length (5.3)	_____ m	Max overall beam (5.5)	_____ m
Draft (5.8)	_____ m	Inboard beam waterline (5.7)	_____ m
Wing above MWP (5.9)	_____ m	Measurement weight	_____ kg
Sailing Weight (a) (5.10)	_____ kg	Sailing Weight (b) (5.10)	_____ kg

Hulls

P centerplane / stern plane angle (6.6)	_____ deg	S centerplane / stern plane angle (6.6)	_____ deg
---	-----------	---	-----------

Rudders

Designated Rudder Port	_____	Designated Rudder Starboard	_____
P rudder from stern plane (8.2)	_____ m	S rudder from stern plane (8.2)	_____ m
P straight line distance (8.5)	_____ m	S straight line distance (8.5)	_____ m

Daggerboards

Designated daggerboard Port	_____	Designated daggerboard Starboard	_____
P straight line distance (9.3)	_____ m	S straight line distance (9.3)	_____ m

Wing

Rotation point above MWP (10.4)	_____ m	Max. half girth differential (10.9)	_____ %
Tall wing weight (10.13)	_____ kg	Short wing weight (10.13)	_____ kg
Tall wing projected area (10.6(a))	_____ m ²	Short wing projected area (10.6(b))	_____ m ²
Tall wing cg (10.13)	_____ m	Short wing cg (10.13)	_____ m

Sails

Hoist point A (12.1(a(i)))	_____ m	Hoist point C (12.1(b(i)))	_____ m
Hoist point B (12.1(a(ii)))	_____ m	Hoist point D (12.1(b(ii)))	_____ m
Tack point A from the stern (12.2(a))	_____	Tack point B from the stern (12.2(b))	_____
Tack point A above MWP (12.2(d))	_____	Tack point B above MWP (12.2(d))	_____
JA (12.4)	_____	JB (12.4)	_____

Measurer: _____

Signature: _____

Measurer: _____

Signature: _____

APPENDIX B — CONSTRUCTION DECLARATIONS**HULL CONSTRUCTION DECLARATION****DESIGNER'S DECLARATION**

I, the designer of the yacht _____

declare that the hull has been designed and to the best of my knowledge, built, only from materials, and using building methods, as permitted in the AC72 Class Rule.

Designer (Block Letters) _____

Signature _____ Date _____

BUILDER'S DECLARATION

I, the builder of the yacht _____ declare that the hull has been built only from materials, and using building methods, as permitted in the AC72 Class Rule.

Builder (Block Letters) _____

Signature _____ Date _____

OWNER'S DECLARATION

I, the owner of the yacht _____ declare that the hull has been built only from materials, and using building methods, to the best of my knowledge as permitted in the AC72 Class Rule.

Owner (Block Letters) _____

Signature _____ Date _____

This declaration is to be preceded by a completed material usage schedule as set out in AC72 Rule 22.2.

COMPONENT DECLARATION

Yacht _____

Component _____ Date _____

DESIGNER'S DECLARATION

I declare that the component named and referenced above has been designed, and to the best of my knowledge, is constructed only from materials, and using building methods, as permitted in the AC72 Class Rule.

Designer (Block Letters) _____

Signature _____ Date _____

BUILDER'S DECLARATION

I declare that the component named and referenced above, is constructed only from materials, and using building methods, as permitted in the AC72 Class Rule.

Builder (Block Letters) _____

Signature _____ Date _____

OWNER'S DECLARATION

I declare that the component named and referenced above, is constructed from materials, and using building methods to the best of my knowledge as permitted in the AC72 Class Rule.

Owner (Block Letters) _____

Signature _____ Date _____

This declaration is to be preceded by a completed material usage schedule as set out in AC72 Rule 22.2.

APPENDIX C — HULL SYMMETRY AND MINIMUM HEIGHT DIAGRAM

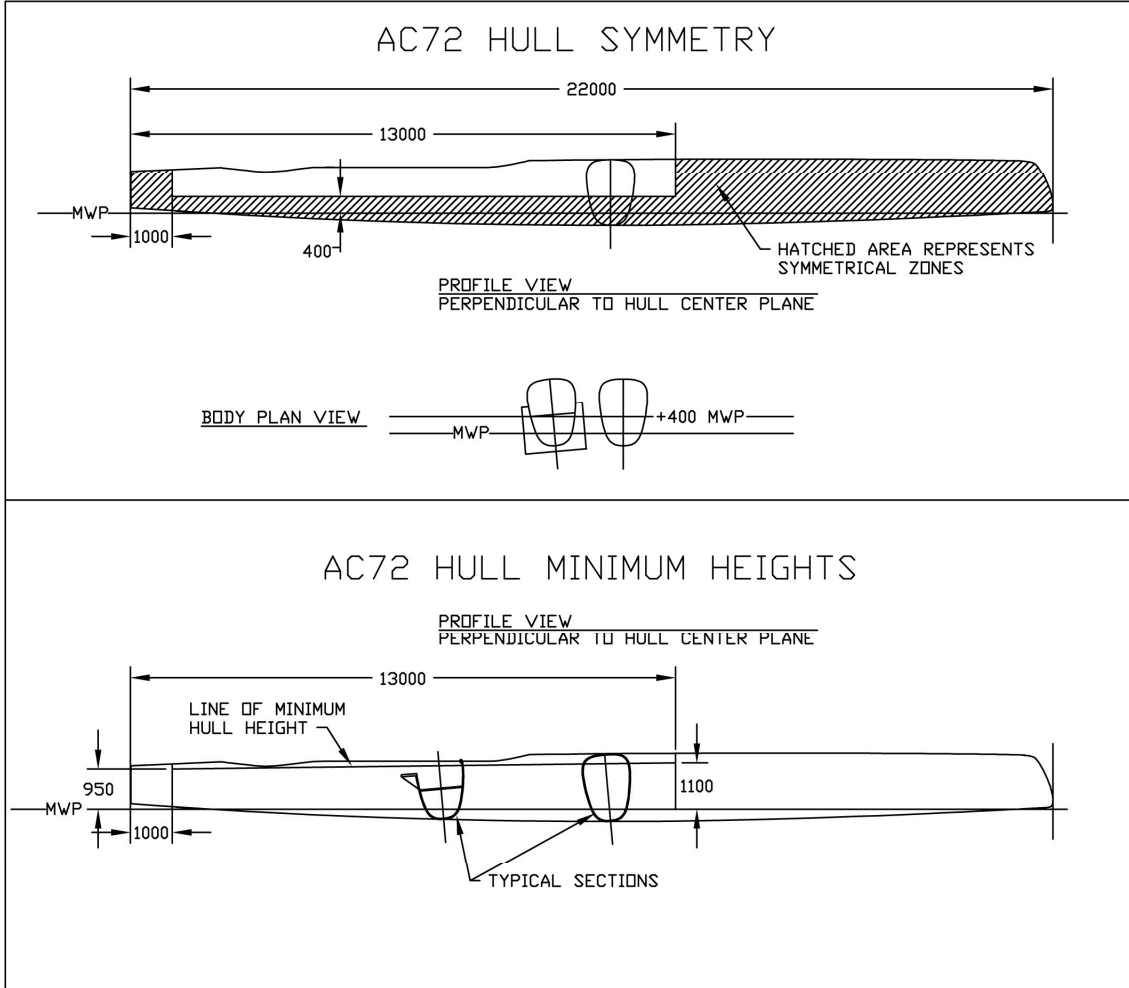

HULL SYMMETRY AND MINIMUM HEIGHT REQUIREMENTS

APPENDIX D — AC72 WING

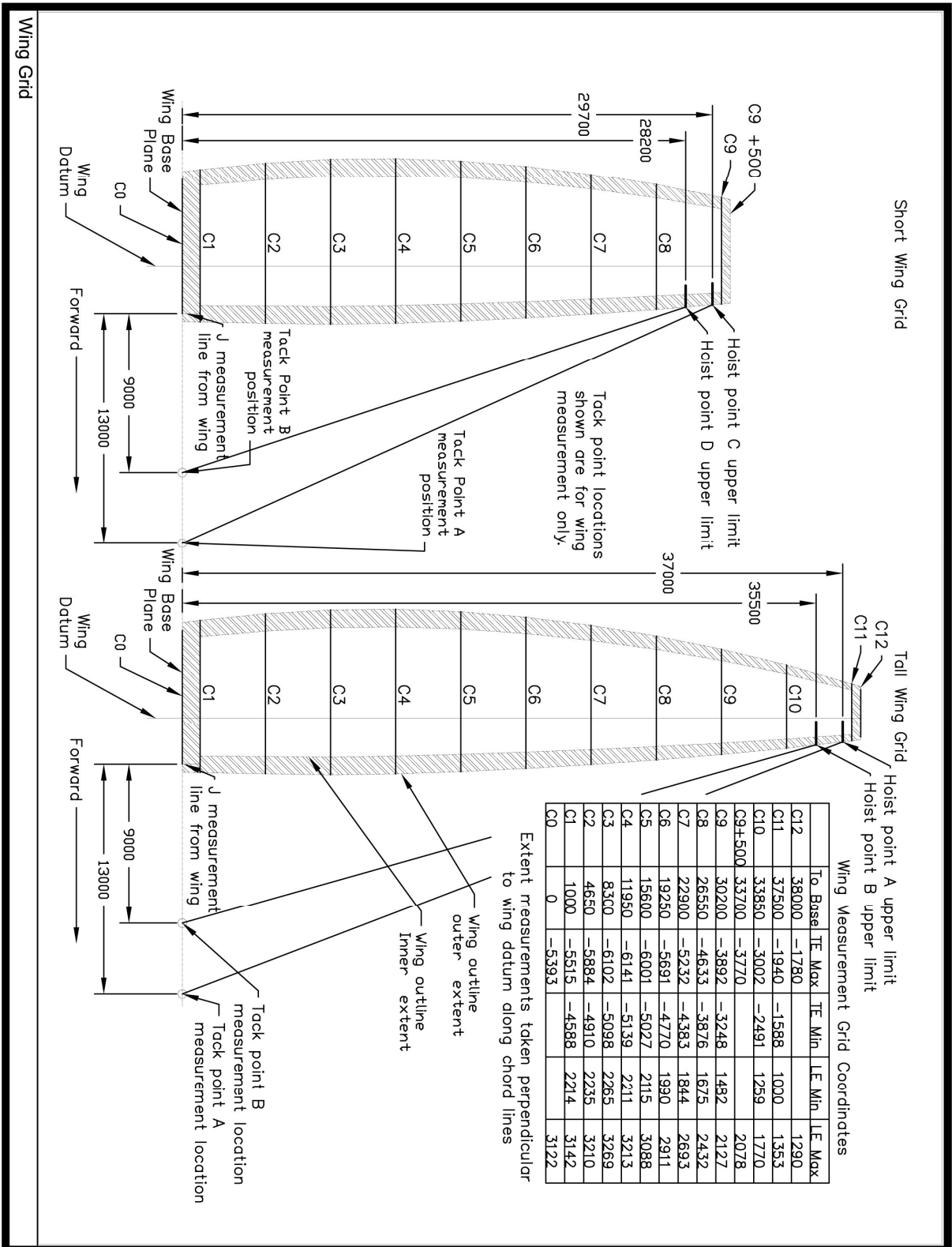

Component Girth

Wing 1/2 Girth

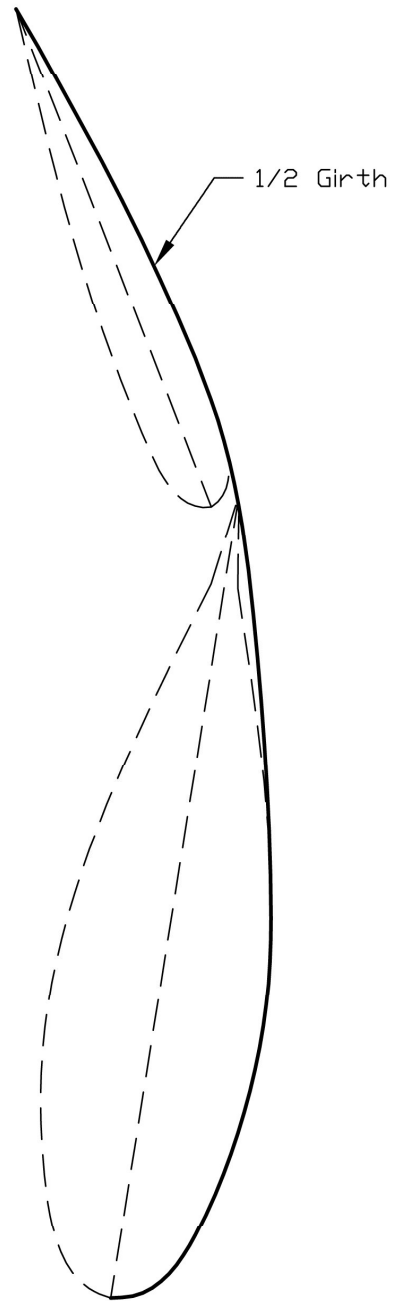
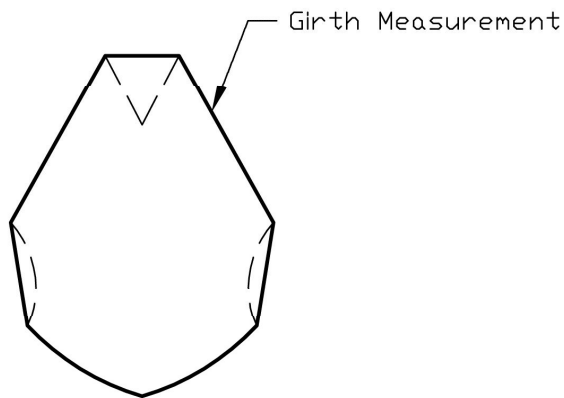
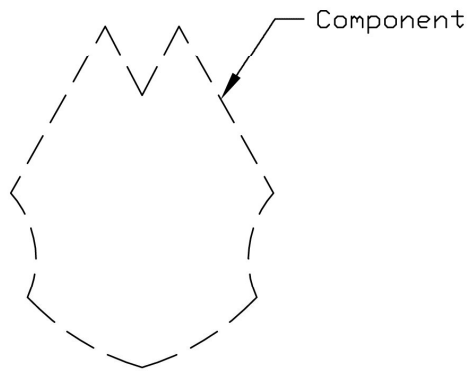

APPENDIX E — MEDIA EQUIPMENT AND PERSONNEL**1. CAMERAS**

1.1 The **AC72 Yacht** shall be fitted with seven HD agile cameras (provided by ACRM). Each agile camera shall be a 200mm sphere weighing 2.0 kg, requiring a 10 mm diameter cable to the media bay and shall:

- (a) be mounted on a common mounting fixture (possibly a 100 mm plate with threaded sockets and 20 mm cable duct); and
- (a) have control and power modulated/bias-T'd onto coax.

1.2 Agile cameras shall be mounted at the following locations:

- (b) on the antenna frame (see Appendix H Rule 6) aft and above the aft-most **cross structure**;
- (c) on the highest extent of the **wing**;
- (d) two in line with the **wing rotation point** on either side of the **wing**, these shall be positioned to allow for filming of the crew;
- (e) on the forward-most extent of the **cross structure**;
- (f) below the aft extent of the **wing**; and
- (g) below the aft extent of the **cross structure**.

If the **Measurement Committee** deems any of the above camera locations to be impractical, they shall specify alternate camera locations, including but not limited to the following:

- (a) at the intersection of the aft-most **cross structure** and **hull** on a 200 mm vertical post;
- (b) below the **cross structure** which supports the **wing rotation point**; and
- (c) in the **hull**, above **MWP** forward of the forward watertight bulkhead.

1.3 The **AC72 Yacht** shall be fitted with three platforms for camera operators with the dimensions 740 mm x 740 mm at the following locations:

- (a) one on the **yacht centerplane**, affixed to the aft side of the aft-most **cross structure**; and
- (b) two in line with the **wing rotation point** at the maximum local beam, with one each on the port **hull** and starboard **hull**.

1.4 If a camera or camera operator platform position interferes with sailing, is unsafe or degrades camera operator performance, ACRM may submit alternative locations to the **Measurement Committee** for approval.

1.5 The camera operator shall have the following equipment:

- (a) one handheld HD camera with stereo microphone;
 - (b) one wireless kit;
 - (c) belt-mounted batteries that are easily replaceable underway with wet-pluggable connectors;
 - (d) receiver antennas on antenna frame (see Appendix H rule 6) and on the structure supporting the **wing rotation point**; and
 - (e) safety equipment.
- 1.6 A four light display shall be fitted to communicate required position to camera operator, indicating the following:
- (a) “Must be on platform”
 - (b) “Ok to weather forward”
 - (c) “OK to weather aft”
 - (d) “OK anywhere”

2. MICROPHONES

- 2.1 There shall be a total of 18 microphones onboard, mounted in the following locations:
- (a) one Surround Sound 5.1 microphone on antenna frame (see Appendix H rule 6). This microphone may be encoded into two audio channels or shall require 6 audio microphone channels;
 - (b) one stereo microphone on cameraman’s camera, using 2 audio channels;
 - (c) wireless mono microphones on 11 crew & observer; and
 - (d) within each **hull**, one microphone shall be mounted no further aft than 3.000 m aft of the **stem** and one shall be mounted no further than 1.000 m from the longitudinal position of the **wing rotation point**.
- 2.2 There shall be a total 20 microphone channels if 5.1 is encoded into two channels, if not, there shall be 24 microphone channels.

3. MEDIA BAYS

- 3.1 The **AC72 Yacht** shall be fitted with two self-draining media bays. One media bay shall be located in each **hull**.
- 3.2 Media bays shall:
- (a) have sufficient volume to house three 1450 Pelican cases with exterior dimensions of 407 x 331 x 175 mm and all associated connecting cables; the cases shall be oriented with handles up and all connectors exiting from the aft end of the cases;
 - (b) have cable access on no less than one end; and

- (c) if a media bay is enclosed, it shall have no less than two 50 mm vent openings and no less than two 50 mm cable openings.
- 3.3 One of the six Pelican cases, to be used for the Inertial Navigation System, shall be mounted in a repeatable, rigid location by one of the following methods:
 - (a) wedge-plate and cam configuration customary in TV cameras;
 - (b) clamp or molded bed built into the bay to receive the Pelican case; or
 - (c) mating plates fastened to the Pelican case and the media bay.
- 3.4 One media bay shall be reserved for batteries with a total system consumption of 400w while operating and 100w while idle. The battery media bay shall house three 1450 Pelican cases, each of which shall:
 - (a) contain eight 2590/U military Li-ion batteries and associated electronics;
 - (b) be capable of three hours of operation; and
 - (c) be safe during discharge unless physically damaged (e.g. crushed or punctured).
- 3.5 One media bay shall be reserved for the following electronics which shall be supplied by ACRM:
 - (a) camera CCUs;
 - (b) video compression processor;
 - (c) video switch;
 - (d) preview compression and Octal split generator;
 - (e) receivers for wireless microphones;
 - (f) audio control, A/D converters, and modulator;
 - (g) CNS-5000 CPT-SPAN INS/RTK GPS, which:
 - (i) shall be mounted in a rigid location that is repeatable with each re-installation of Pelican case;
 - (ii) may be mounted onto a plate with index pins;
 - (iii) may be mounted with a “wedge-plate” and cam; and
 - (iv) shall be mounted in a location precisely surveyed on each boat for config file.
 - (h) control computer;
 - (i) ethernet switch;

- (j) telemetry transceiver;
- (k) microwavetransmitter;
- (l) power control, conditioning; and
- (m) interface to **Competitor** electronics, if any.

4. CABLING

4.1 Cables for media purposes shall be provided by ACRM and shall have an onboard connection point that is pre-mounted and molded onto the **AC72 Yacht**.

4.2 Cable paths shall include:

- (a) between media bays;
- (b) to a zone near the **wing rotation point** and then to the **wing** conduit;
- (c) to antenna shelf (see Appendix H Rule 6);
- (d) to camera locations;
- (e) to microphone locations; and
- (f) to **Competitor** electronics;

4.3 Cabling shall be routed to the media bay via routes specified by the **Measurement Committee**.

4.4 Excess cable shall remain in a media bay and be cut off and connected by **ACRM**, who shall bag, label, and provide cutoff cable ends to **measurers** if requested by them.

5. INSTRUMENTS ATOP THE WING

5.1 The **AC72 Yacht** shall have the following antennas, each with a 100 mm whip (provided by ACRM) located at the highest extent of the **wing**:

- (a) microwave PA/LNA with dimensions 150 mm x 75 mm x 75 mm, weighing 1.5 kg; and
- (b) two-way telemetry PA/LNA with dimensions 15.0 cm x 7.5 cm x 5.0 cm, weighing 1 kg.

5.2 A conduit tube with an inner diameter of 40 mm shall be fitted from top to bottom of the **wing**. This conduit shall allow for:

- (a) the passage of one LMR400, one CAT6 ethernet, and
- (b) a conduit chosen to easily pass connectors.

6. ANTENNA FRAME

6.1 The **AC72 Yacht** shall be fitted with one antenna frame located aft of and above the aft-most **cross structure** on **yacht centerplane**. This antenna frame shall be large enough to

accommodate the following ACRM-provided media equipment and any **Competitor** cableway:

- (a) one cameraman antenna;
- (b) two wireless microphone receiver antennas;
- (c) one GPS antenna;
- (d) one agile camera near the **yacht centerplane**;
- (e) one Surround Sound 5.1 microphone mounted on a post near **yacht centerplane**;
and
- (f) one magnetic compass.